

Elvira 2

By Flair Software

C-64 Version Walkthrough v1.0

Written by Miroslav Micic (VoodooFX)

Preface

Anyone who ever searched for a walkthrough of a Commodore 64 version of Elvira 2 soon realized there are only PC/Amiga ones out there. And if you tried to follow any of them, you soon ended up scratching your head as to where in the world might Studio 3 be.

Needless to say, Elvira 2 was such a huge game, that C-64 conversion had to cut some corners in order to work with system's limitations. And the Studio 3 was one of the things that got cut out of the game.

About 5 years ago, I finally overcame the last few obstacles, which had me stumped for quite a long time, and actually managed to finish the game.

At that point I took it upon myself to write a walkthrough... for all Elvira fans out there.

Well, after 5 years of waiting, here it is.

While I won't cover every monster-fighting tactics, I will provide solutions to abolishing enemies, which can only be defeated in a certain way. What I will also include are: full catacomb and studio maps (studio maps where necessary) to help you avoid venturing into unnecessary dead ends, thus sparing you some tedious backtracking.

Right, enough of the jibber-jabber and on to the walkthrough, shall we?

1. The entrance to the studio complex

From your starting point, turn around and pick up **the rock** in lower right corner and **a strange fungi** from a lower left corner (not really visible, but it's there).

Turn around again and head to the gate. Locked!

Turn right and head for the door.

Face the door and throw a rock at it.

Enter the guard room and open the door on the right. A dead guard will fall out.

Navigate back to the entrance and turn around to face the guard on the floor.

Take **the keys** and walk behind the desk.

Look at the console and insert the key.

Type-in the requested code (copy protection). The gate is now unlocked!

Head outside and onto the parking lot, where a single car resides.

Go to back of the car and pop the trunk.

Take **the wire-cutters** from the tool box.

Off to the complex!

2. Studio complex

Once inside, head straight for the door in front of you.

Pick up **the fire extinguisher** and walk to the elevator on your right.

Call the elevator by pushing the button.

Enter it and turn around to face the control panel.

Push "2" for a ride to the 2nd floor.

For your convenience I've included the layout of the floor.

2nd floor:

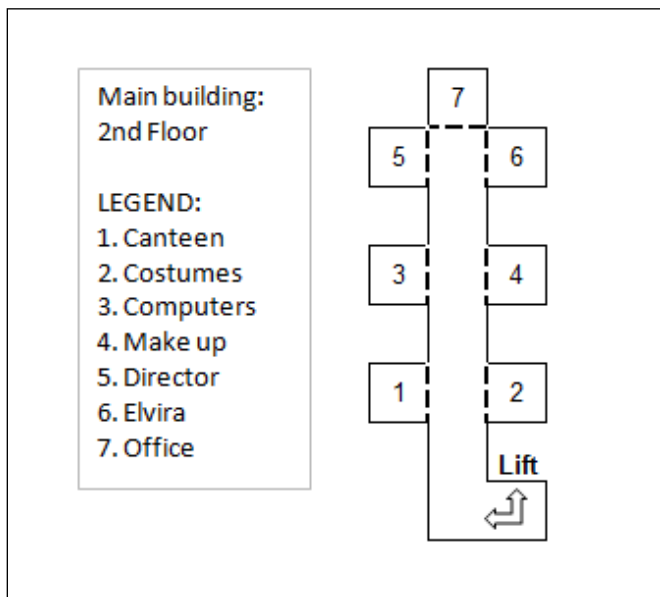

Enter the Canteen (1) and pick up a **bowl of sugar** from the right table. Also grab some **sticky buns** from the counter (two dots from what looks like a cash register).

Exit and enter Computers room (3). Let's leave Costumes (2) alone for now.
Pick some **floppy disks** from one of the drawers.

Let's enter the makeup room (4) after that.

Approach the mirrors in front of you. Pick up **the wig** and **the helmet** from the heads on display. There is a make-up box by the left mirror. Look inside and take **the glasses**. Don't put anything on just yet!

Exit and head for Director's room (5).
Take **the bottles of whisky and brandy** from the club table.

Nothing else here, so proceed to the next room – Elvira's room (6).
Pick up a **box of tissues** and a **lucky charm** from a make-up box. Click the "Room" icon (second icon in the user interface), which reveals a hidden object – a **nail file**. Take it.

Enter the last room – the Office (7).
Browse through the drawers, one should contain **an axe** (unusual place to keep one, eh?). Grab it and click on it once, then select "USE" from the action menu on the right. This will equip the axe as a weapon. Exit the room.

Head for the room we skipped – Costumes (2)

Mix an "**Ice Dart**" spell from your **Spell book**. Enter the room, where you'll be immediately attacked by a one-eyed witch.

Shoot a few Ice dart spells at her or fight her with an axe you equipped earlier (sword icon in the upper right corner).

After defeating her, you'll receive an **eye of a witch**.

Grab a **lab coat** and **the wizard's tunic** from the stands. Look inside the tunic to find a **rapier**.

We're done with this floor so let's head back to elevator and take a ride down to basement.

Basement:

No need for a map here, head straight ahead and through the door.

You'll see an elderly Native American sitting on the floor. Approach him and a mouth icon will appear in the interface. This means you can talk to him.

Ask him for help and he'll drop some clues about what's going on and a certain location you'll need at the end.

Then ask him to give you the spear and he'll list three items you'll need to bring him:

- a broom
- his pipe of peace
- and a flint

Both doors in this place are locked for the moment, so there's nothing left to do here.

Let's head back to the main floor and into the studios.

3. Studio 2

We will cover Studio 2 first.

Enter the studio and you'll see an old house short distance ahead. Head for the main door and enter.

Studio 2 – Base floor:

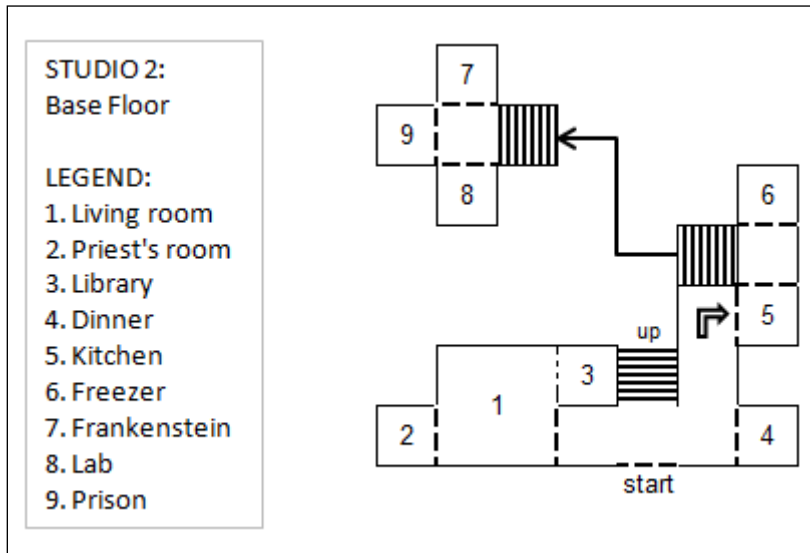

Once inside turn right and approach the door, but don't enter just yet.

Facing the door, turn left.

On a shelf you'll see something resembling a vase, take it only to find out, that it's actually **a barometer**.

From here you can take two ways. Both lead to the same part of house, but different starting point.

You can go straight ahead or face the door on your right. I'll take the latter, but feel free to try them both.

So, turn right and enter the [Dining room \(4\)](#).

If you want to gain a few EXP points then lift the lid from the plate on the table, otherwise turn left.

Go for the cabinet door. Open it.

Once awake, you'll find yourself in a [Freezer \(6\)](#). Mark the text in your inventory window!

Turn around and from the shelves pick up **a strong smelling cheese, bottles of chilled wine, a loaf of chilled bread and a joint of meat**.

Right, it's time to leave this joint. What did the text say, again? "Warm things up!" Mix a **"Fireball"** spell with **box of tissues** as an ingredient.

Use the Fireball spell while facing the door, which will result in raising the room temperature, but also raising the alarm in the process.

Try to leave and you'll be attacked, by a knife-swinging lunatic.
Defeat him and leave the room.

Turn right and walk down the stairs.

You'll see a [prison cell \(9\)](#) in front of you. Don't bother with it, it's empty. There are a couple of doors here, one to left and one to the right.

Turn left and enter the [room housing the Frankenstein's monster \(8\)](#). Don't worry, it isn't alive... yet.

Once inside, turn left and take **a bottle of a purple liquid, a heart in a jar, a preserved arm and a brain in the jar.**

Turn right or left two times to face the opposite side (turn icon won't work for some reason).

Pick up both sets of **test tubes.**

Don't operate the lever by the monster, or if you must, be sure to return it into "Off" position! Exit.

There's nothing we can do in [Lab room \(7\)](#) for the moment.
So let's backtrack and enter the [Kitchen \(5\)](#).

There are many things to pick up here, so let's get busy.

Pick up all **dinner plates** right in front of you.

Turn left and take all the **sauce pans** from the wall.

Turn left again and take the **steel bucket**. Look inside it to find **a horse shoe**. Take **yellow tin, collection of tins** and **jars of food** from the shelves.

Look inside the **yellow tin** to find **a medicine bag**.

Turn left once more and grab **basket of various fruits, eggs, meat cleaver** and **a meat hammer**.

Before you exit the door in front of you, mix a "**Turn undead**" spell using **brain in a jar** as an ingredient.

Exit and turn left. You will be attacked by an undead or a zombie if you will.
Vanquish him with the Turn undead spell, you prepared just moments ago.

Head for the stairs you were facing, when you entered the mansion. On the crossroad take a left turn.

Studio 2 – 1st floor:

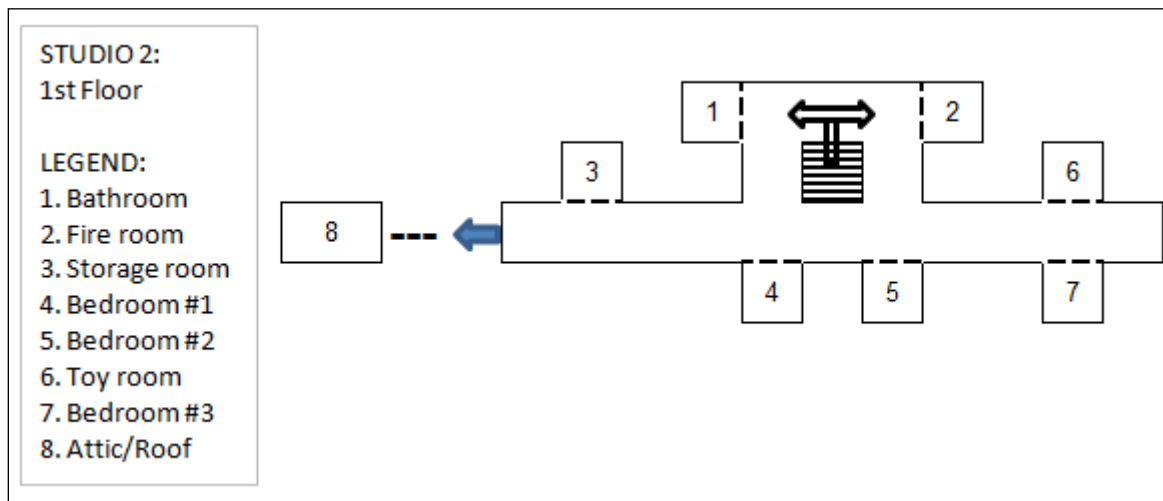

Enter the [Bathroom \(1\)](#) and take **the bath sponge**. Exit.

Enter [Bedroom#1 \(4\)](#) and walk to the center.

Turn right and go for the bed. Click on it, since “walk forward” arrow won’t work, although active.

Remove the blood-stained sheet which reveals a body holding something.

Try to pry it from his hand and a ghost will rise from the corpse and attack you. Fight it.

Yes, even physical weapons will work.

Finally, take the paper – **a photograph**. Examine it.

Also, there is **a small ornate brass key** sticking from his shirt pocket. Take it as well.

Step back from the bed. Now here is a part I doubt anyone could figure out on his/her own.

Click on the lower half of the left bed’s leg. You’ll raise the bed sheet to reveal a hidden button.

Press it and then press R to return.

By doing this you’ve opened a hidden door on the right side of the bed.

Click on the passage and walk through the corridor.

Pick up ten **satanic candles** and **a gold chalice** from the altar. Don’t look up, there are vampires sleeping. Return to the bedroom. Exit.

There is nothing to do in [Bedroom#2 \(5\)](#), so let’s proceed to the [Toy room \(6\)](#).

Look for **a rubber ball** and take it.

Warning: Before entering [Bedroom#3 \(7\)](#) be sure to mix a “**Courage**” spell from your spell book, using **Brandy, Whisky** or **a bottle of chilled wine** as an ingredient. Use it. You’ll die otherwise.

Enter the room and after the cutscene grab the **pillow**. Look inside and you’ll find **a tuning fork**.

Walk to the Storage room (3) and enter. Take **a pair of ladders** by the window and **box of matches** from the first crate.

There is something that you need for [Attic/Roof \(7\)](#) which we don’t have at this moment, so we’ll leave it alone for now.

Head all the way back to the **Main building** and into the basement, where our good friend Indian sits and waits.

Once there, click on the boiler room door and it will open (by using a small brass key we took from the dead guy on the bed).

Enter the room and turn around, take the **copper rod** and a **steel key**. Exit.

Open the janitor door on the right (unlocked by a **steel key** you've just picked). Grab a **broom**.

You can give the **broom** to the Chief right away, or you can give it to him later with the rest of the stuff he wants. Your choice.

Now, return to the **Studio 2**, up to the first floor and enter the [Attic/Roof \(7\)](#).

Once there, QUICKLY use the **tuning fork** to break the window.

Daylight from the window will kill the vampire coming at you.

Set up the **pair of ladders** under the window and climb to the roof.

Place the **copper rod** along the chimney wall.

Mix a "**Summon Storm**" spell using a **barometer** as an ingredient. Use it - enjoy the lightning storm.

Head downstairs to the [Living room \(1\)](#). Once inside, turn right and approach the door leading to the [Library \(3\)](#).

You will be stopped by a friendly ghost. Click on it and the message will say "Give it something to play with". So give him a **rubber ball**. It will disappear, so our way to the Library is clear.

Feel free to read some of the books, since some puzzle solutions are hinted here (some we already covered though). Just make sure you read the one in Reference section!

Films – first and the last shelf.

Humour – first and last shelf (last shelf contains some important info, so try to remember some of it).

Horror – first and the last shelf (books describe the monsters you have, or yet have to encounter).

Reference – third shelf contains book of poisons. Read it and something will fall to the floor.

Click the room icon and pick up a **piece of paper containing a chemical formula**.
the last shelf

Occult – first shelf contains important information on "**Revive**" spell

(All the necessary ingredients are hinted here) ****[Read the note](#)****

Medicine – first and the third shelf

Exit the library and take a walk down to the [Laboratory \(8\)](#).

Before entering put on the **lab coat**, **the glasses** and a **wig**, so you'll look like the guy from the photo – a lab assistant.

Enter the lab and ask the guy to mix you a potion. Give him the **piece of paper containing a chemical formula** from the library and you will receive a **bottle of toxic poison**.

Leave and take off the costume (lab coat, glasses and wig).

Enter the [Frankenstein room \(7\)](#). Be sure you have a **pair of wire cutters** handy in your inventory. Pull the lever and the monster will attack you. Use the **pair of wire cutters** and it'll drop as a dead fly. Click on the stand where Frankie was resting moments ago to reveal a secret passage. Enter.

You'll see Elvira tied to a pole. Don't move!

Mix a "**Nova**" spell using a **bottle of Whisky** or a **bottle of Brandy**. Approach Elvira and she will turn into a monster. Kill her with the "**Nova**" spell.

Return to the main hall and revisit the [Living room \(1\)](#). But this time head for the [Priest's room \(2\)](#).

In front of it grab a **steel helmet** and a **steel gauntlet** from the armor set on the right.

Enter the room and turn right to face the fish tank. Make sure you have a **joint of meat** and a **bottle of toxic poison** in the same inventory screen since in order to combine the two; you'll need to drag the poison onto the meat. Takes a little precision for it to work, but you'll manage.

Once you're successful, you'll own the **poison meat**.

Approach the fish tank and drop the **poison meat** inside. Piranhas will enjoy their last meal.

Take the **small brass key** from the bottom of the tank. Take a step back and turn left.

Approach the wall. Click on the hole to reveal a hidden safe. Open it and take the **pipe of peace**. Well that's two down, one still to go.

Step back and turn left, look inside an ornate desk and take the **bible**.

Well that's all there was to be done in Studio 2, so it's time we visit Studio 1.

** There seems to be a bug in the game, where combining all the necessary ingredients won't produce the Revive spell. I'll touch on this more in the next chapter. **

4. Studio 1

Type in the security code and enter the studio.

Walk through the graveyard and enter the chapel.

Turn left and head for the fountain. There is a head lying on the floor – a dismembered priest!

You should be on high enough level to mix a **“Revive”** spell in order to revive him.

As I mentioned previously, there seems to be a bug in a game, since if you follow the guidelines from the library to the letter (mix a heart, a brain, skin and something dear to the deceased), you’ll get **“Wrong ingredients !!!”** in the status window.

In order to mix a **“Revive”** spell successfully, you **ONLY** need the **heart in a jar, brain in a jar and a preserved arm**. Use the spell while facing the priest and he’ll appear in your inventory.

You can fill couple of **test tubes** with the holly water from the fountain.

Turn around and head for the altar. You’ll be attacked by Angel of Death. Kill it using a melee weapon or some spell.

Pick up couple of **golden candles** and a **golden cross**. Move the pulpit from the left side – drag it into inventory for it to disappear. A secret passage way will be revealed.

Climb down.

You’ll be attacked by two Shivas. Use a **“Fireball”** spell, to take them both out in a single strike.

Continue your descent until you enter catacombs – the most time consuming part of the game.

For your convenience I’m giving you full layout of all 6 levels, as promised.

That’s why I won’t be covering them step-by-step, in a written word. There is really no point.

Your goal is to pick up **a sharp flint** on **Level 1** and find **Elvira** on **Level 6**. Yes that is all.

There are some other rocks you can pick on various levels. Do so, on your free will, but the two aforementioned goals are a **MUST**.

Map explanation: maps should be more or less straightforward, green letters represent descending holes; so if you, for instance:

- descent through the hole “green A” → you’ll enter Level 2A on “blue A” being your starting point.
- so blue letters basically represent the holes, through which you ascend back to the upper levels.

Here is the quick guide of catacombs:

Pick a flint on Level 1 → Head to hole B on same level - Level 1 → In Level 2B descend down the hole B → on Level 3B+C drop down the hole B → on Level 4B enter hole A → on Level 5A enter hole A → on Level 6A navigate to Elvira → lastly backtrack your steps and return to chapel.

LEVEL 1

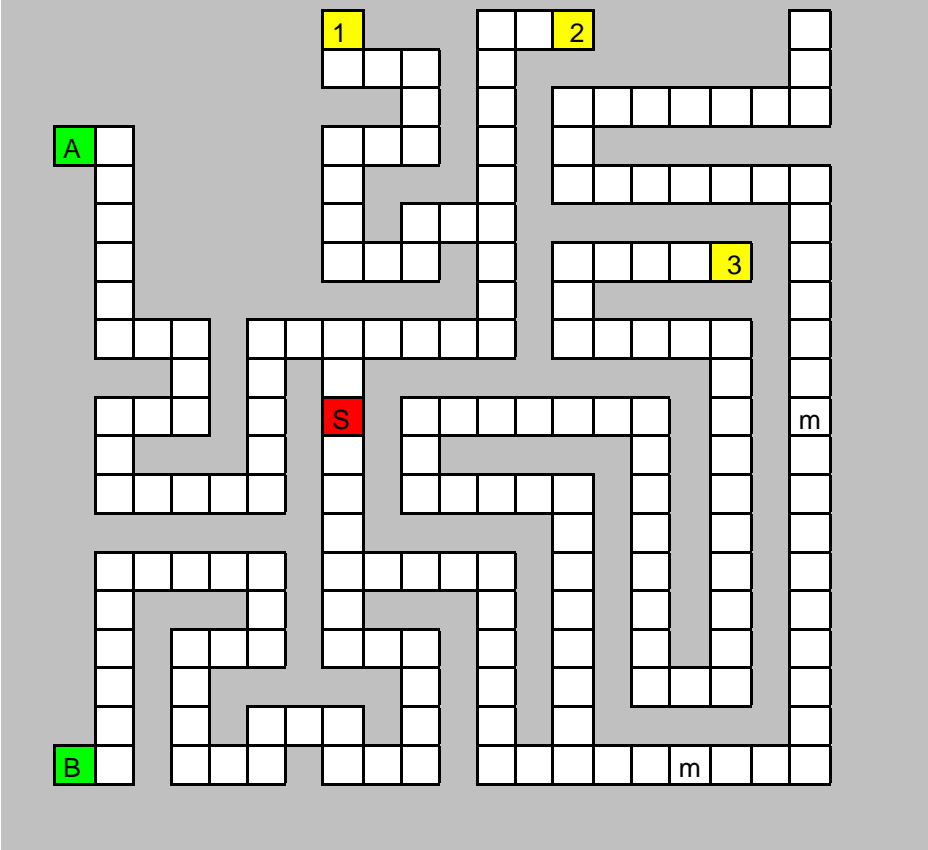

S – Starting point

1 – Garnet

A – down to Level 2A

m - monster

2 – Amethyst

B – down to Level 2B

3 – A sharp flint

LEVEL 2A

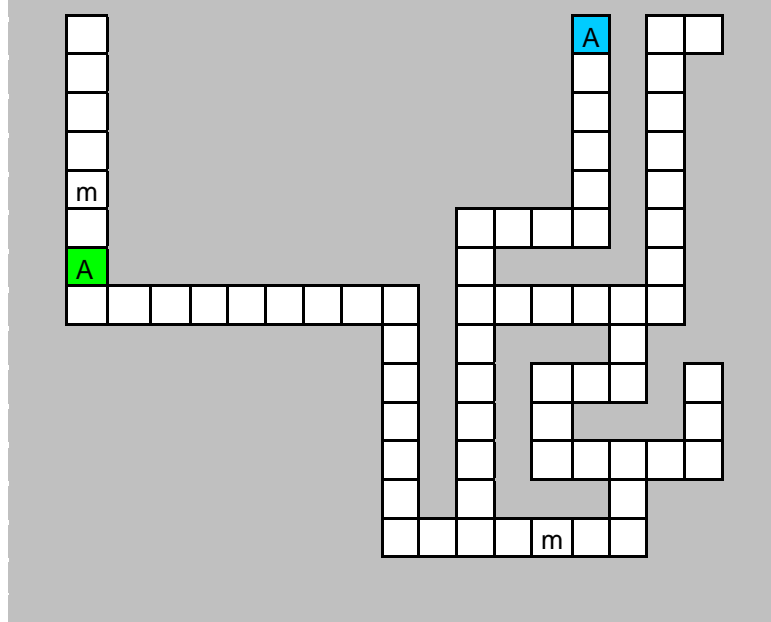

m – monster

A – down to Level 3A

A – up to Level 1 (hole A)

LEVEL 2B

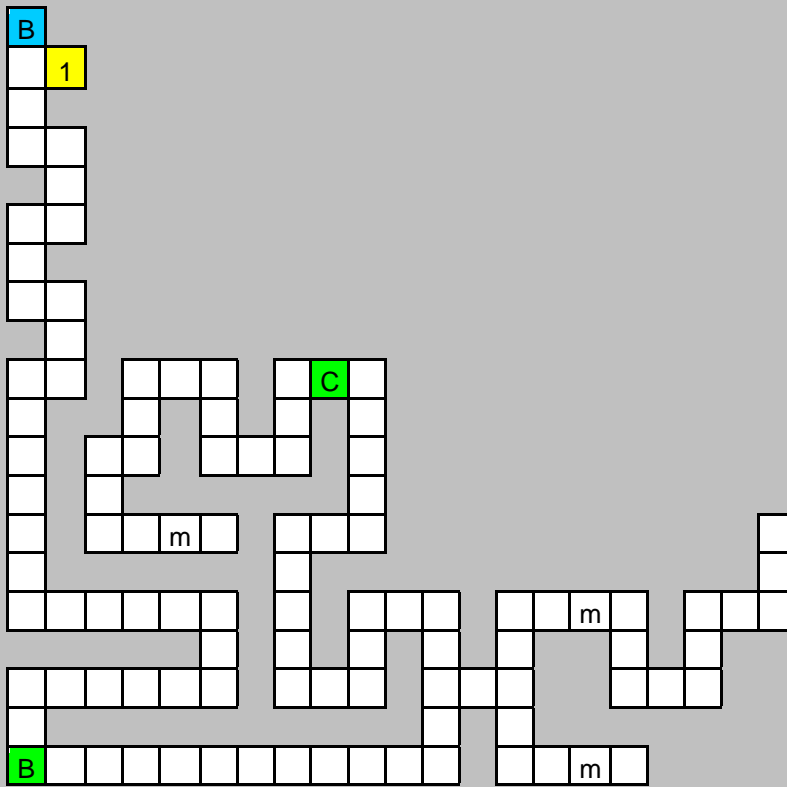

1 – an Emerald

m – monster

B – down to Level 3B+C

C – down to Level 3B+C

B – up to Level 1 (hole B)

LEVEL 3A

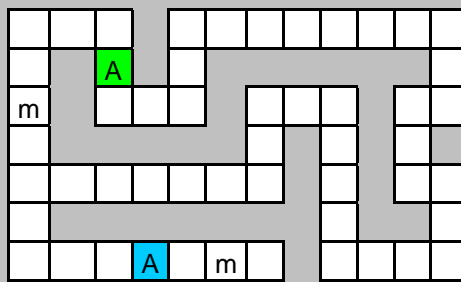

m – monster

A – down to Level 4A+C+D

A – up to Level 2 (hole A)

LEVEL 3B + C

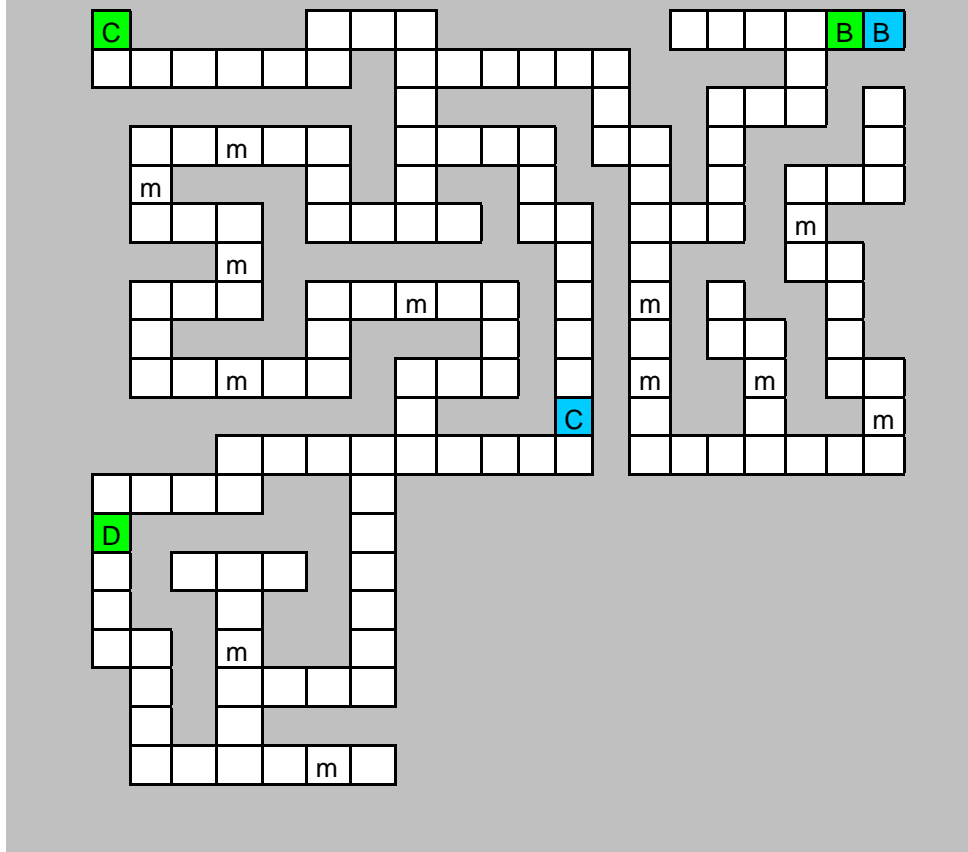

m – monster

B – down to Level 4B

C – down to Level 4A+C+D

D – down to Level 4A+C+D

B – up to Level 2B (hole B)

C – up to Level 2B (hole C)

LEVEL 4A+C+D

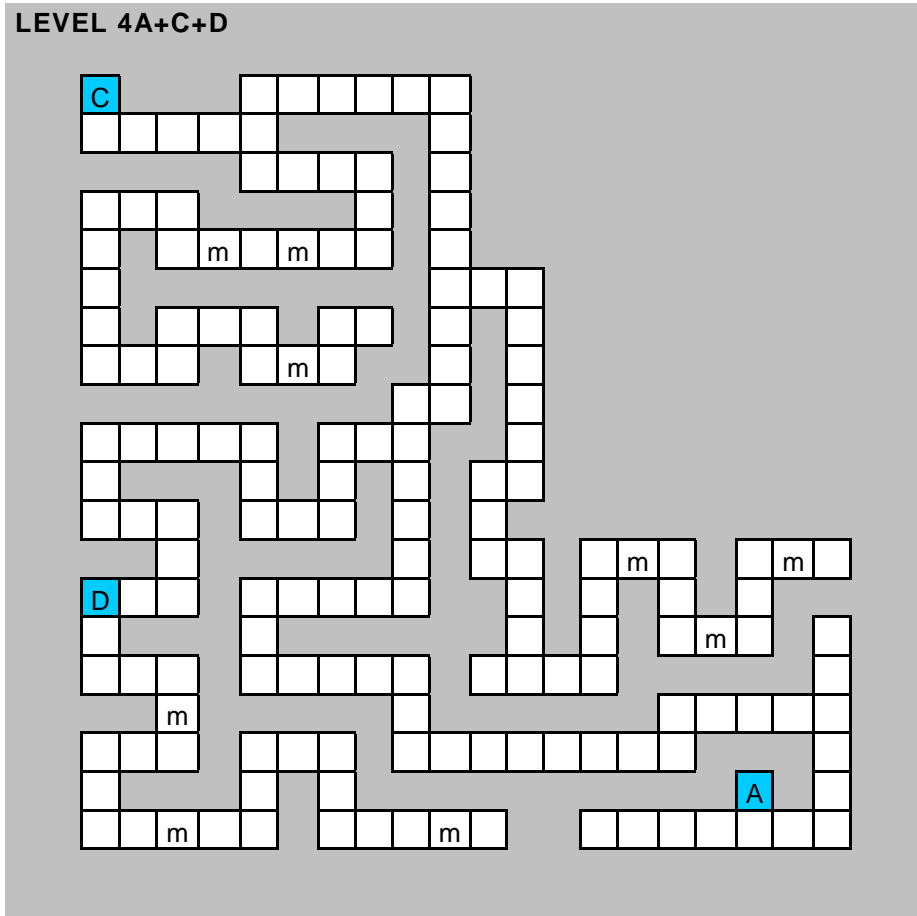

m – monster

A – up to Level 3A

C – up to Level 3B+C (hole C)

D – up to Level 3B+C (hole D)

LEVEL 4B

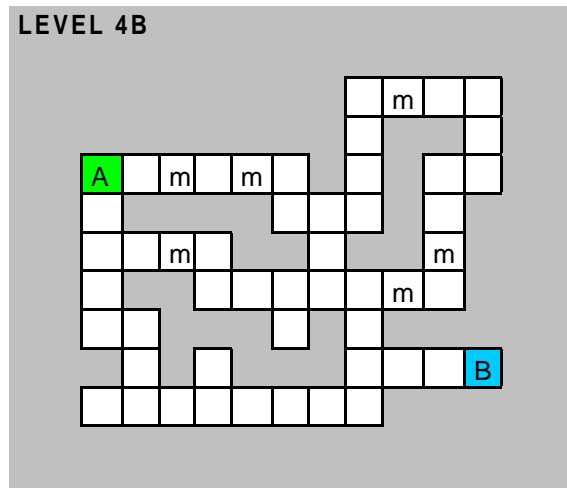

m – monster

A – down to Level 5A

B – up to Level 3B+C (hole B)

LEVEL 5A

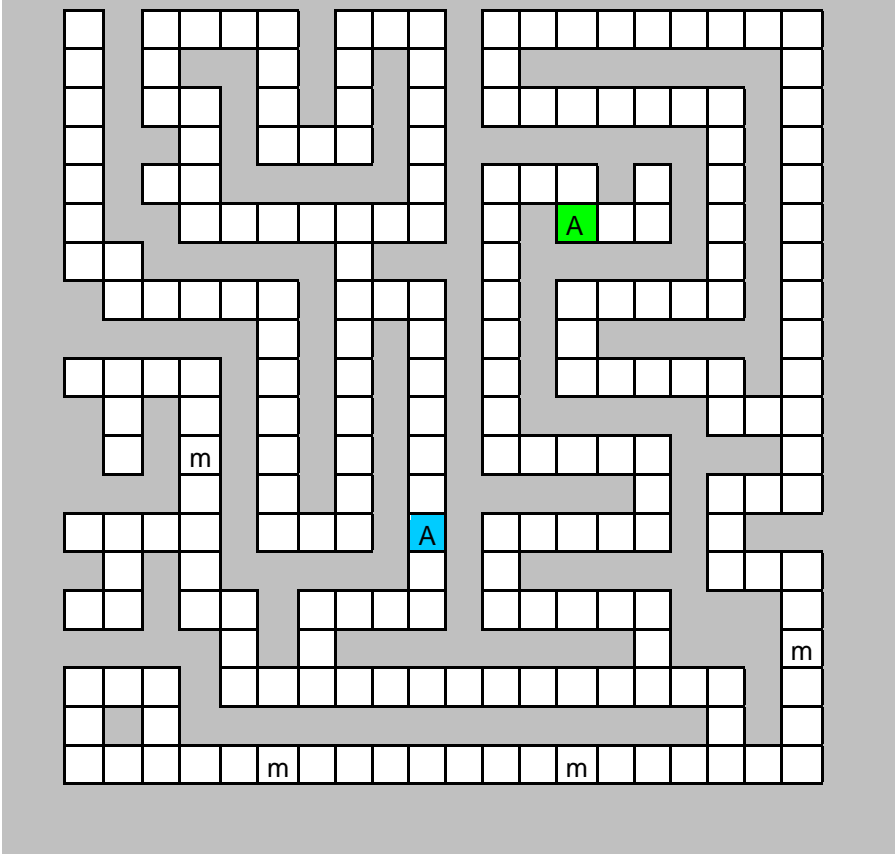

m – monster

A – down to Level 6A

A – up to Level 4B (hole A)

LEVEL 6A

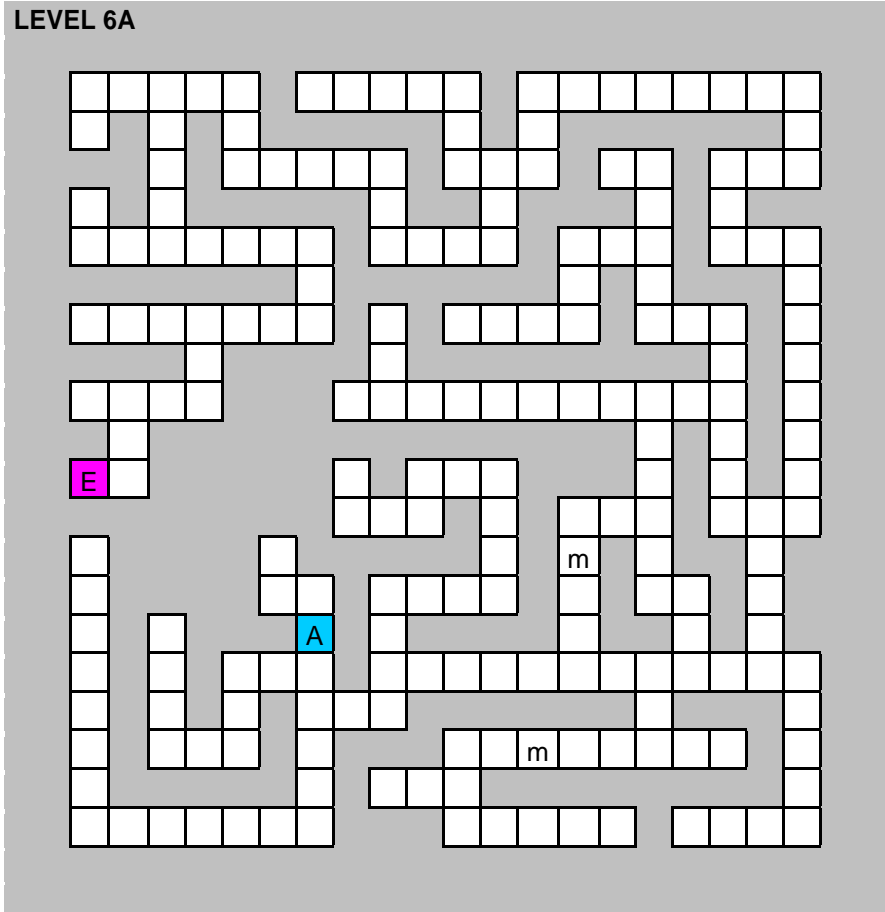

m – monster

A – up to Level 5A

E – Elvira

Once you return to the surface, its endgame time.

5. Finale

Enter Studio 2 one last time and go to the [Dining room \(4\)](#).

Lift the lid from the set on the table. This time you won't faint so take some blood from the plate. (drag it into inventory and it will automatically be stored in **a test tube**.)

Return to the main complex and ride the elevator down to the Basement.

Approach the Chief and give him the three quest items: **a broom, a pipe of peace and a sharp flint**.

Talk to him and ask him to give you the spear; since he now has all the necessary items, he'll hand you **the spear**.

Head for the parking lot.

Before we do anything, mix a **"Bind Demon"** spell with **a rope** as ingredient. Also, mix a **"Resist fire"** spell and couple of defensive spells won't hurt either (if playing an untrained game – limited Health and Power points)

Arrange the inventory so you'll have **a spear** and **an axe** (make sure it's **an axe** and not the **meat cleaver!!**) on top. This way you won't waste the time scrolling and searching for the necessary items during the final battle.

Walk to the car and turn right to face the gate. Use the **"Resist fire"** spell. Then use the **priest**.

After Cerberus rises from the ground, use a **"Bind demon"** spell on it.

Quickly, throw **a spear**.

Two heads are dead, but the third will keep on attacking you.

Use **an axe** on it and you'll hit the heart.

Enjoy the completely lame ending.

6. Conclusion and "legal" stuff

I hope you enjoyed the game and found this walkthrough even in a slightest way helpful. If it helps a mere single soul on the planet, then the work and time spent on gluing it all together, was well worth it. Should you find any mistakes contact me via [email](#), and I'll correct them ASAP.

You may distribute this document freely in its current form.

I would only kindly ask of you, should copy any of the content found here (maps, etc) that you please give credit, where credit is due.

Thank you,
Miro